



AL MANARATAIN

(ISO 9001 certified company)



P.O. Box 926, Kingdom of Bahrain, Arabian Gulf
Tel. : 594595, 590097, 400333, 701104, Fax : 591267
Website : www.almanaratain.com e-mail : alshaab@batelco.com.bh

CONCRETE BLOCK PAVING

Concrete block paving consists of small individual high strength concrete units manufactured to accurate dimensional standards and locked in place between edge restraints. The blocks are laid without mortar on a sand-laying course.

APPLICATIONS

- ◆ Residential landscaping
- ◆ Parks & play areas
- ◆ Pedestrian precincts & footpaths
- ◆ Parking areas
- ◆ Private roads
- ◆ Docks & harbors
- ◆ Public roads
- ◆ Storage yards
- ◆ Industrial floors

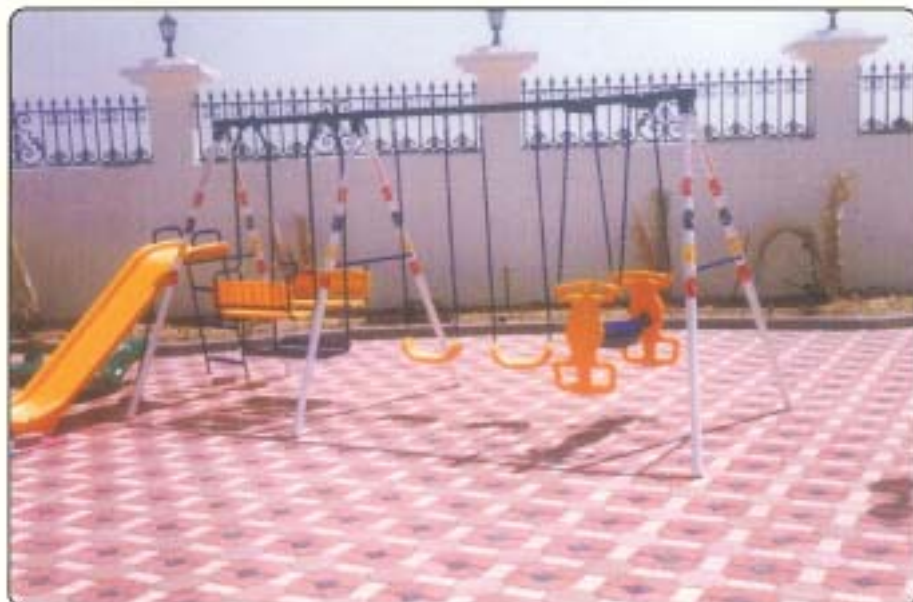

ADVANTAGES

- ◆ More strength
- ◆ Durable
- ◆ Easy to fix
- ◆ Ready for use immediately
- ◆ Practical for large or small areas
- ◆ Re-useable
- ◆ Dust free environment
- ◆ Cooler in summer
- ◆ Less maintenance
- ◆ Major cost saving
- ◆ Visually pleasing with attractive colour choice

HOW TO LAY CONCRETE BLOCK PAVING

Laying concrete block paving is a straight forward job. The only special tools needed are

1. A mechanical compactor for bedding the block and can also be used for compacting and finishing the sub-base.
2. A hand operated stone splitter or concrete grinder for cutting blocks.

Fixing method and preparation

In case of agriculture land or loose land we have to follow the below procedures.

1. Desert fill to be compacted after spreading and watering.
2. Crusher fine to be spreaded over the desert fill and compaction to be done.
3. Edging kerbs to be fixed if required (as shown).
4. 50 mm thick washed sand bed to be levelled and compacted.
5. Concrete block pavings to be fixed over the sand bed.
6. Again sand to be spreaded over the Concrete block pavings to fill the gaps.
7. Final compaction and cleaning to be done before handing over.

MAINTENANCE

Concrete block paving needs little or no maintenance. If the paved area needs to be opened up / or access to underground services, the block can be removed and fixed again easily. Only a small number of replacement blocks are required for such situations, and the reinstatement will leave no unsightly scars of patching.

AVAILABLE COLOURS

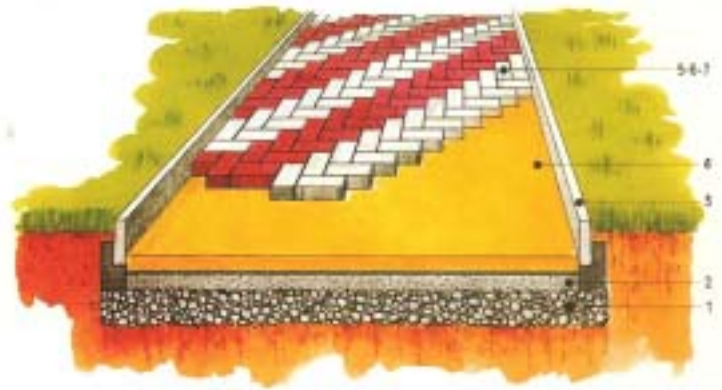

Thickness to be used

- Industrial areas subject to heavy trafficking - 80 mm thick interests
- Residential roads - 80mm thick Interests
- Car parks and lightly trafficked areas 60mm (80mm thickness if likely to be regularly trafficked by heavy commercial vehicles.)
- Pedestrian areas - 60 mm thick interests
- Home gardens and walkways around villas - 50mm thick interests.

Handling Mechanical off-load

Al-manaratain can provide a clamp unloading service which dispenses with the need for the customer to provide manual or fork-lift site off-loading. The time taken to unload is considerably reduced.

RECTANGULAR PAVING BLOCK

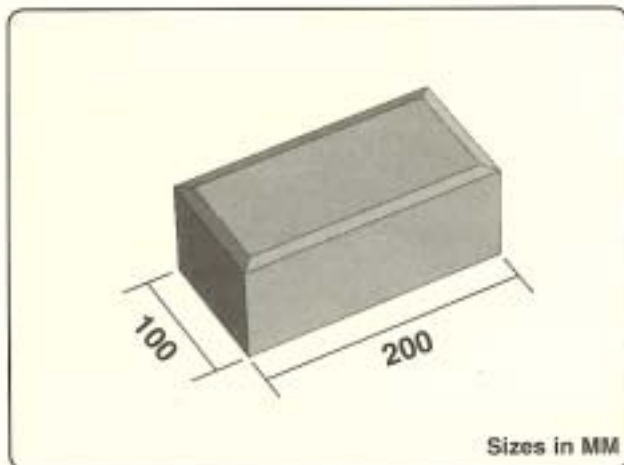

TECHNICAL DATA

SIZE (MM)	100 x 200		
Thickness of paving	50	60	80
No. of paving / m ²	50	50	50
Tolerance - width / Length	± 2	± 2	± 2
Thickness	± 3	± 3	± 3

COMMON LAYING PATTERN

Paving blocks may be laid in a variety of patterns including traditional stretcher bond, basket weave, 90° herringbone and 45° herringbone. Where rectangular blocks are used in subjected to vehicular traffic, herringbone is recommended.



STRETCHER BOND



BASKETWEAVE



45° HERRINGBONE



90° HERRINGBONE



UNI - PAVING BLOCK

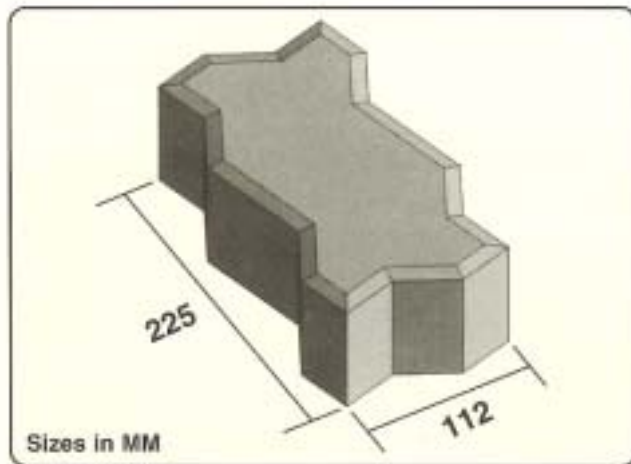

TECHNICAL DATA

SIZE (MM)	112 X 225		
Thickness of paving	50	60	80
No. of paving / m ²	40	40	40
Tolerance - width / Length	± 2	± 2	± 2
Thickness	± 3	± 3	± 3

COMMON LAYING PATTERN

Uni - paving may be laid in a variety of patterns including traditional stretcher bond, basket weave, 90° herringbone and 45° herringbone. Where Uni-Paving blocks are used in subjected to vehicular traffic, herringbone is recommended.

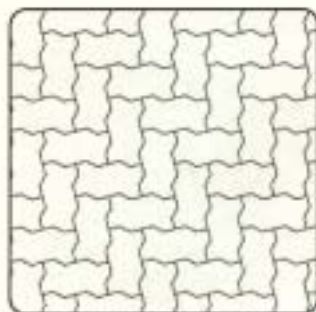

90° HERRINGBONE

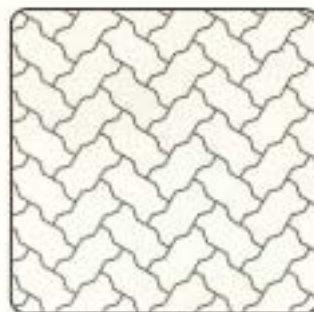

45° HERRINGBONE



BASKET WEAVE



STRETCHER BOND





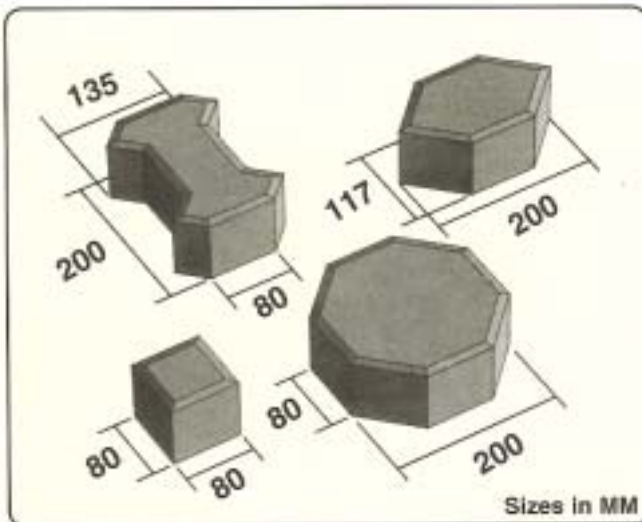

QUADRO PAVING BLOCK



Your surroundings reflect your taste. Add colour to your home, play and work area with quadro. Choose the pattern with suits you best. The possibilities are endless with Quadro - the basic patterns can be varied with the different colours that make each design unique.







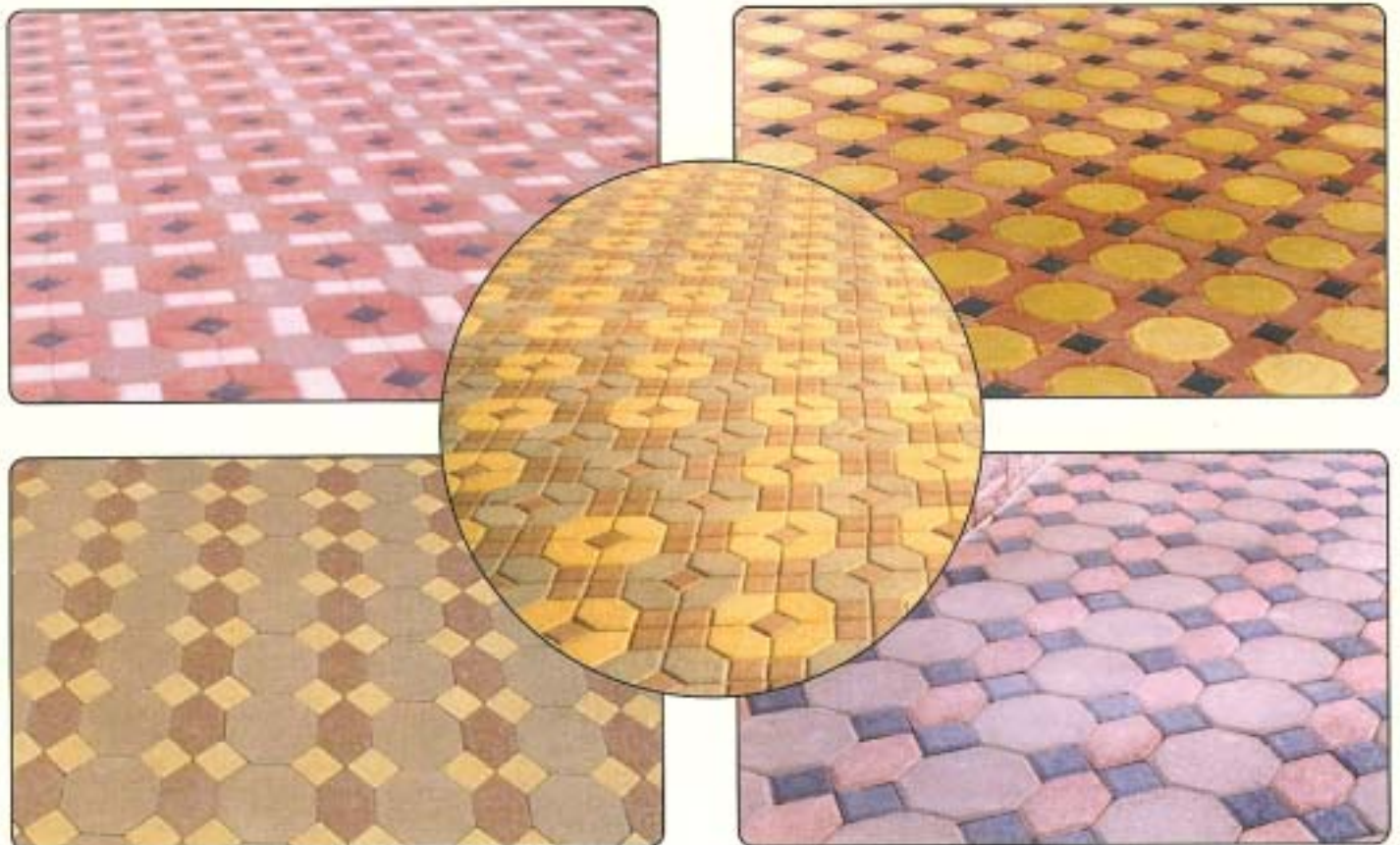



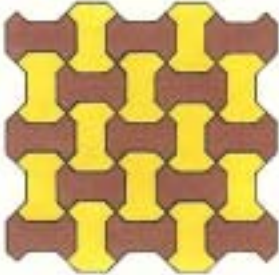





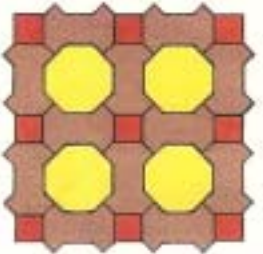



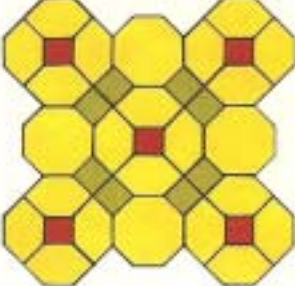



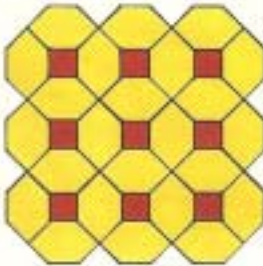

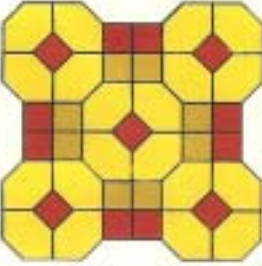



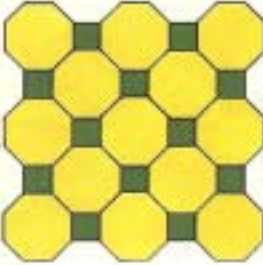

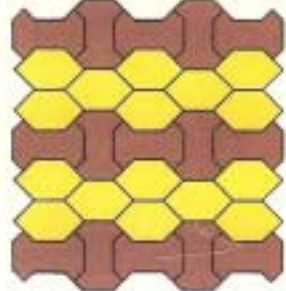
From single colour to multi colour patterns quadro is the most economic and flexible way of adding robust colour to your project. Quadro is available in more than ten colours, each colour blends in harmoniously and add beauty to modern architecture or traditional homes.

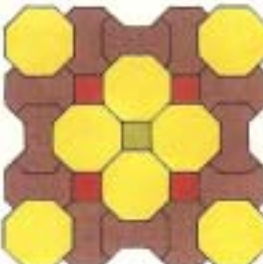
TECHNICAL DATA

PAVING TYPE	octagon shape 	square shape 	I-shape 	diamond shape 
Thickness of paving	60	60	60	60
No. of paving / m ²	31	157	52	64
Tolerance - width / Length	±2	±2	±2	±2
Thickness	±3	±3	±3	±3

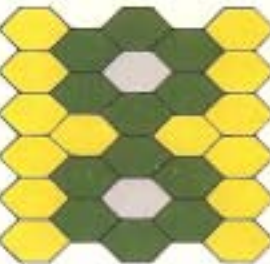

COMMON PATTERNS FOR QUADRO PAVING

 <div data-bbox="479 283 690 430">  0.5000  0.5000 </div>	 <div data-bbox="1185 262 1388 472">  0.5313  0.2572  0.2115 </div>
 <div data-bbox="479 598 690 808">  0.4936  0.0841  0.4224 </div>	 <div data-bbox="1185 567 1388 829">  0.4925  0.2025  0.2544  0.0506 </div>
 <div data-bbox="479 966 690 1081">  0.8294  0.1706 </div>	 <div data-bbox="1185 934 1388 1134">  0.6605  0.2037  0.1358 </div>
 <div data-bbox="479 1312 690 1438">  0.8340  0.1660 </div>	 <div data-bbox="1185 1281 1388 1428">  0.4459  0.5541 </div>
 <div data-bbox="479 1564 690 1816">  0.3690  0.0838  0.0209  0.5263 </div>	 <div data-bbox="1185 1585 1388 1774">  0.4167  0.5000  0.0833 </div>

- The combinations shown above are only a small selection among almost ultimate possibilities of formation.
- The above mentioned proportions are approximate quantities in each square meter. It may vary due to site conditions.

THREE-D PAVING

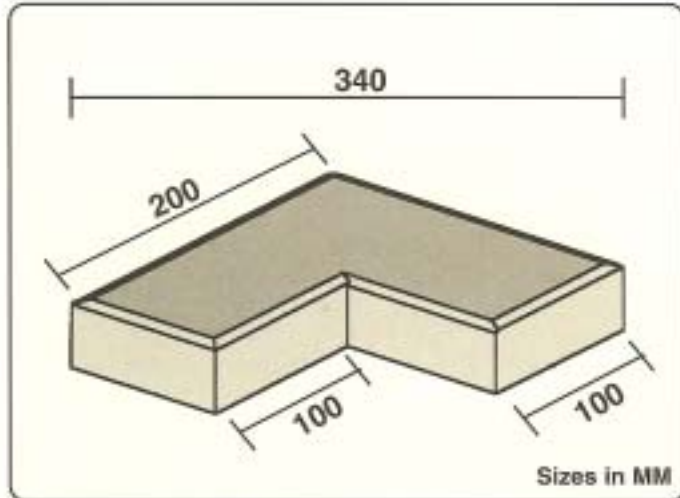

The Three-Dimensional paving with its illusionary effect attracts every viewer. The deceived game between light and shadow seems to transform surfaces into three dimensional objects. An effect that suits perfect for design accents.

TECHNICAL DATA

SIZE	As Shown
Thickness of paving	60
No. of paving / m ²	39
Tolerance - width / Length	± 2
Thickness	± 3



OTHER SHAPES AVAILABLE

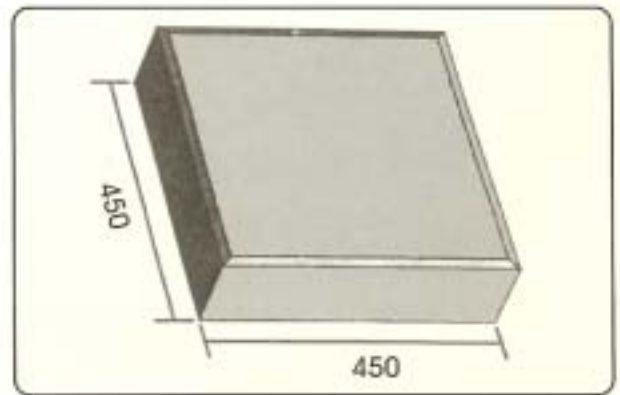

PAVING SLAB

Size	:	450 x 450mm
	:	5 Nos. per m ²
Thickness	:	50 mm
Colours	:	Refer Page No. 2



COBBLE STONE

Size	:	200 x 200 mm
	:	25 Nos. per m ²
Thickness	:	60, 80 mm
Colours	:	Refer Page No. 2

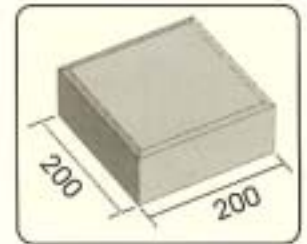

UNI - DECOR PAVING

Size (Nominal)	:	
Standard Block	:	227 x 137 mm
	:	40 Nos. per m ²
Edge Block Large	:	137 x 110 mm
Edge Block Small	:	87 x 87 mm
Thickness	:	60 mm
Colours	:	Refer Page No. 2

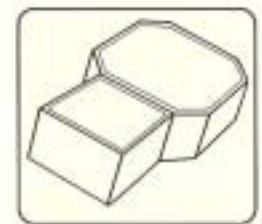

✦ This is a marketing catalogue and not for specification.

✦ The colour on this catalogue are subject to the limitations of photograph reproductions, always see our actual sample before placing your order.

For any further information on these products please contact the sales desk at

AL MANARATAIN

P.O. Box 926, Kingdom of Bahrain, Tel. : 594595, 400333, Fax : 591267
www.almanaratain.com e-mail : alshaab@batelco.com.bh